



GENUINE PARTS

iPod INSTALLATION INSTRUCTIONS

1. DESCRIPTION: iPod

2. PART NUMBERS:	iPod Gateway Module Kit ('07)	999U7-VR002
	iPod Gateway Module Kit ('05-'06)	999U7-VR000
	N-Bus harness for iPod Gateway	999U7-VS000
	N-Bus harness for [optional] SAT Radio	999U7-VS001

3. MODEL APPLICATION: FRONTIER, PATHFINDER & XTERRA (2005~)

4. iPod GATEWAY MODULE KIT CONTENTS (999U7-VR000/2):

No.	Parts	Qty	Parts View
A	iPod Gateway Module	1	
B	Cable tie (8")	12	
C	Cable tie (15")	6	
D	Double-Sided Tape	1	
E	Foam Tape	9	
F	Grommet	1	
G	Alcohol Wipe	1	
H	iPod Cable	1	
I	Quick Reference Card	1	
J	Owners Manual	1	
K	Service Info Insert	1	
L	Critical Installation Info	1	

5. PRE-INSTALLATION CAUTIONS/NOTES:

CAUTION

- Dealer installation recommended. This installation instruction will reference the service manual.
- Cut the excess cable tie(s) as flush with the head as possible. Face head of cable tie away from sheet metal and other objects.
- Use caution when removing/re-installing interior components to avoid damage, scratches, or breaking of mounting clips.

NOTE

- This is a universal installation kit so all parts may not be used.
- Refer to the vehicle specific SAT radio Installation Instructions on ASIST.NET for further information.
- Ensure the Owners Manual and Quick Reference Card are placed in the customers glove box.
- Check the customer's iPod to make sure it has the most current software version before starting the install. (www.apple.com/ipod)

- In the event the iPod system needs to be serviced, order the iPod Service Kit below.

iPod Gateway Service Kit 999U7-VS002SP

6. TOOLS & MATERIALS REQUIRED:

1. Masking tape
2. Phillips screwdriver (#2)
3. Plastic Pry bar
4. PGF Stick
5. Drill
6. 1/8", 11/16" drill bits
7. Electrical tape
8. 1/4" driver w/ 10mm socket

7. CRITICAL INSTALLATION STEPS:

- (1) Make sure there are no interference issues when routing harnesses around the parking brake mechanism.
- (2) Ensure the module is mounted level with or above the horizontal cross member to avoid interference with the iPod cable.

8. INSTALLATION OUTLINE:

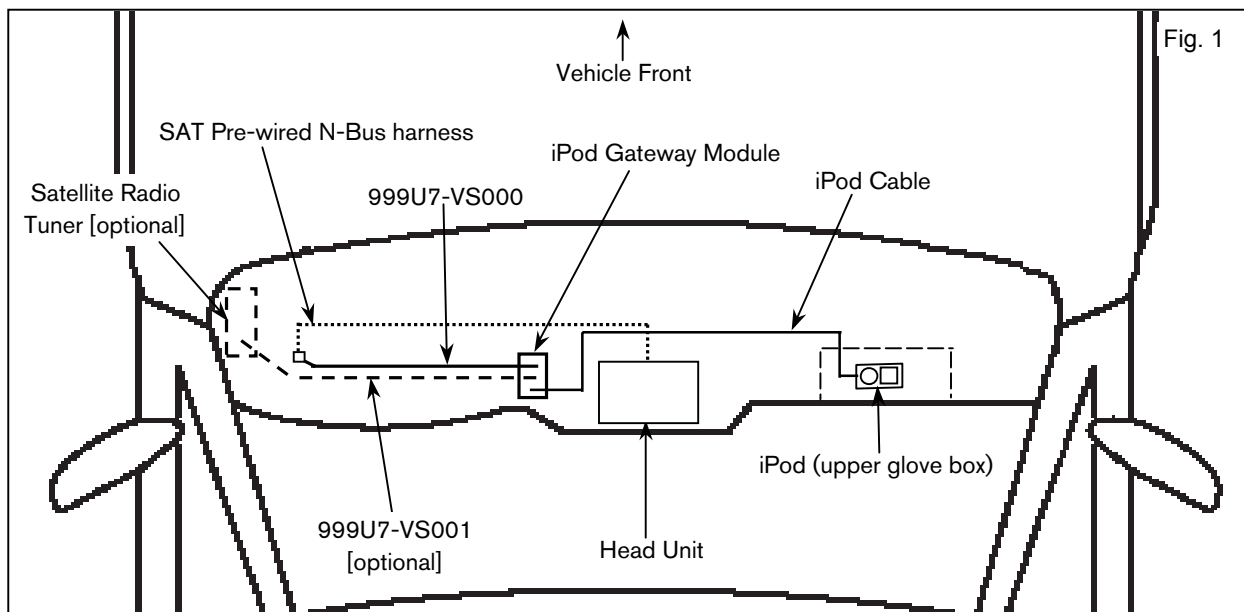

9. VEHICLE PREPARATION:

- (1) Apply parking brake.
- (2) Record the customer radio presets.

Preset	1	2	3	4	5	6	7
A							
B							
C							

- (3) Make sure that the shift lever is engaged in the "P" position.
- (4) If equipped, move the adjustable accelerator/brake pedals to the front most position.
- (5) Turn the ignition switch OFF
- (6) Open engine hood.
- (7) Disconnect the battery negative terminal to prevent short circuits during installation.
- (8) Remove the following interior parts as shown in Fig. 3 (Refer to vehicle service manual). Apply masking tape to interior parts adjacent to parts being removed.
 - a) Front pillar lower finisher LH/RH
 - b) Lower driver instrument panel LH
 - c) Lower Glove Box assembly
 - d) Upper Glove Box assembly

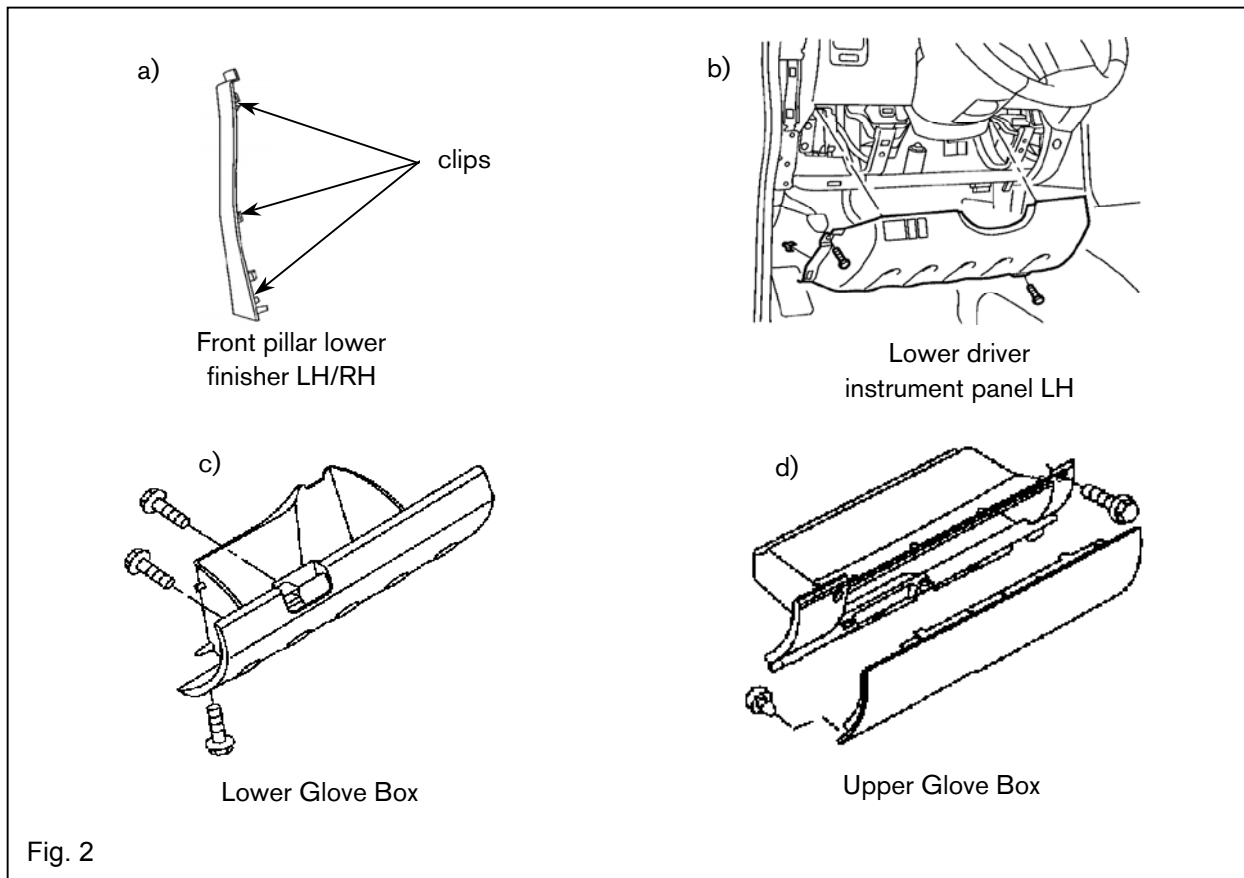

10. CABLE ROUTING (iPod GATEWAY & [OPTIONAL: SATELLITE RADIO]):

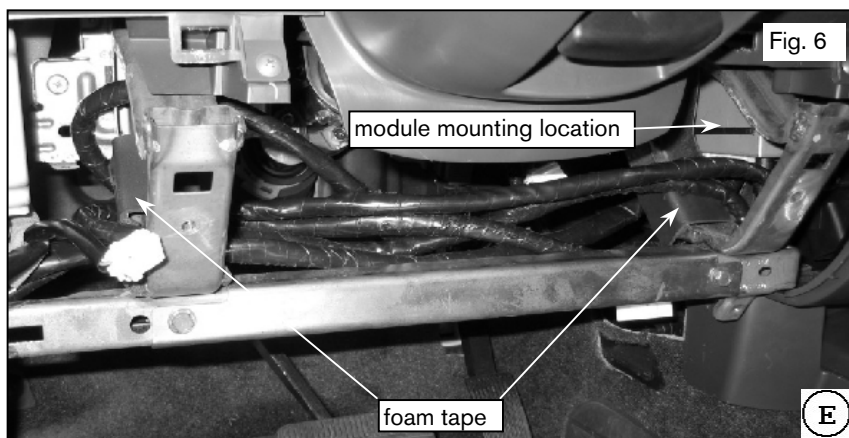
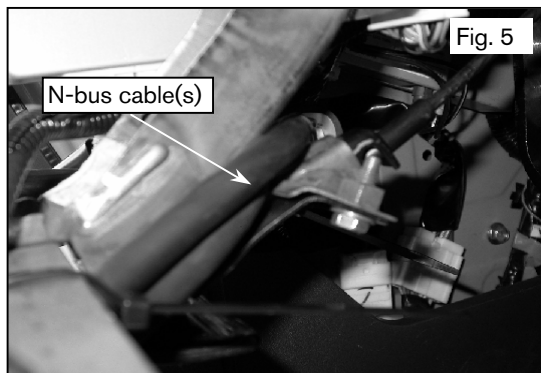
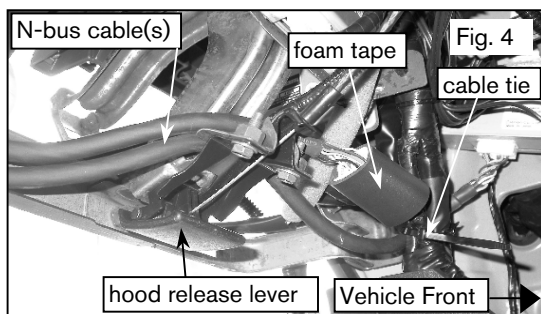
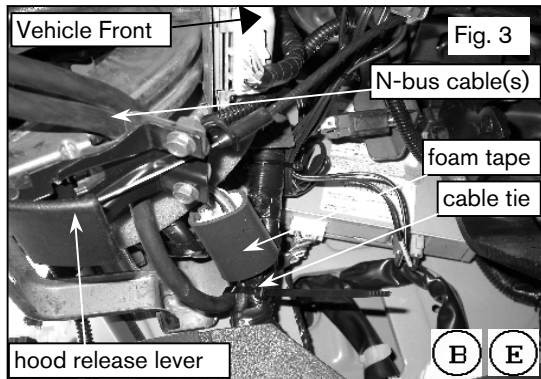

- (1) Insert the corresponding connector of the iPod gateway harness into the vehicle's prewired N-Bus. From vehicle's N-Bus prewired connector start by routing above the rear section of the hood release lever mechanism and into the C-channel to the right of the hood release. [Optional: Connect corresponding connector of the Satellite harness to the correct tuner connector. Route cable the same as iPod gateway harness.] Fig. 3 & 4
- (2) Secure the prewire and [Optional: satellite bus cable] with one (1) cable tie around the large harness that the prewire originates from. Fig. 3 & 4
- (3) Wrap one (1) piece of foam tape around the connectors of the prewire and iPod N-Bus Harness. Fig. 3 & 4
- (4) Ensure the cable is not interfering with the hood release and is as tight as possible against the metal frame. Fig. 4 & 5
- (5) Place two (2) pieces of foam tape on the front inner section of the U-shaped frames. Fig. 6
- (6) Route cable(s) along the C-channel to the mounting location area.
- (7) Wrap the cable(s) 2 times around the RH U-shaped frame where the foam tape was placed. Fig. 6

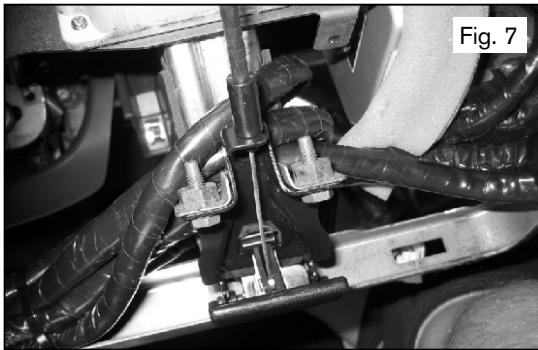

(8) Route cable(s) back towards the hood release lever again. Wrap cable(s) around the LH U-shaped frame where the foam tape was placed and back towards the mounting location. Fig 7

(9) Repeat steps 7 & 8 again and complete routing at module mounting location.

(10) Leave cable(s) dangling until the module installation later.

(11) Secure the bundled cable(s) with two (2) cable ties around the bundle and the C-channel. Fig. 8

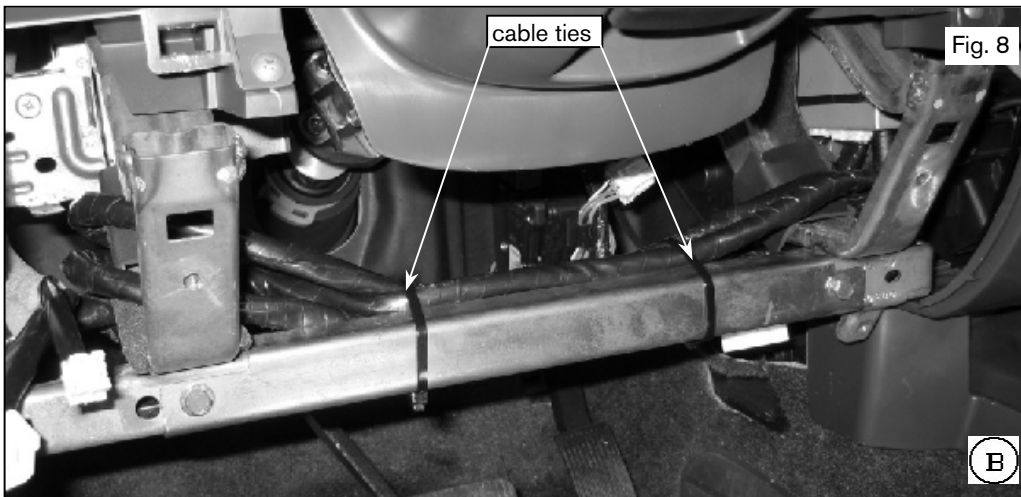

11. CABLE ROUTING (iPod CABLE):

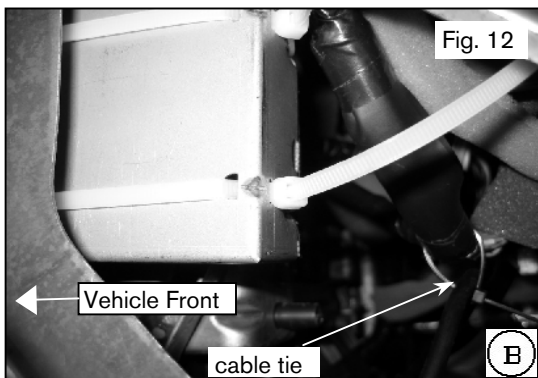
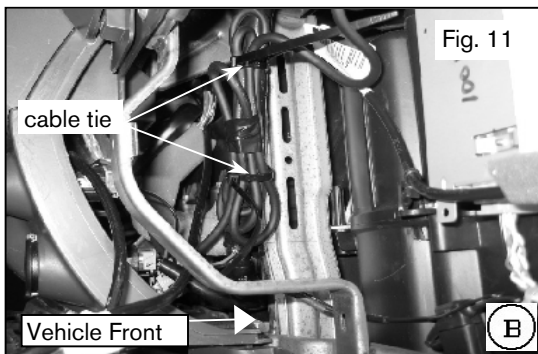
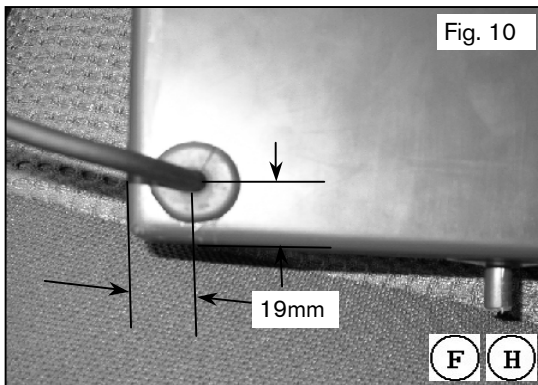
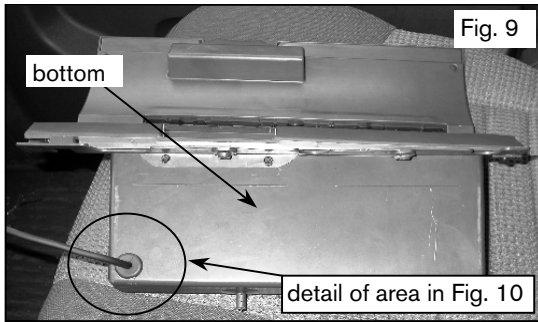

- (1) Using a 1/8" bit drill a pilot hole in the bottom LH side in the rear of the upper glove box 19mm +/- 2mm (0.75in) from both nearby edges of the box. Open up the hole to 11/16". Fig. 9 & 10
- (2) Mark the cable 460mm (18.125") from the iPod end (rectangular connector). Start routing iPod cable from inside of glove box with DIN connector end (round connector). Route out of glove box through the drilled hole. Place grommet over wire and feed into drilled hole in glove box. A PGF stick or other plastic prying tool may be helpful. Fig. 10
- (3) Re-install the upper glove box per the service manual.
- (4) With glove box re-installed pull the cable until the mark on the cable is equal with the grommet. Route cable into cavity behind HVAC controls to other side of IP.
- (5) Leaving enough room to connect to the iPod module, bundle the excess cable (5"-6" loop). Wrap electrical tape around the bundle in two (2) places for at least two (2) revolutions. Secure the bundle with two (2) cable ties to the harness below the upper glove box. Fig. 11
- (6) Secure cable near module with one (1) cable tie to harness directly to the right of the module mounting location. Fig. 12

12. iPod GATEWAY MOUNTING:

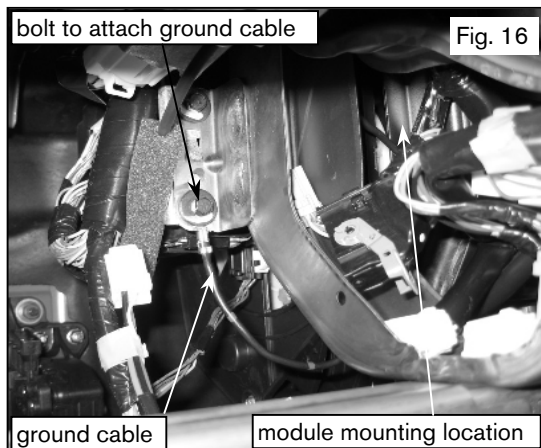
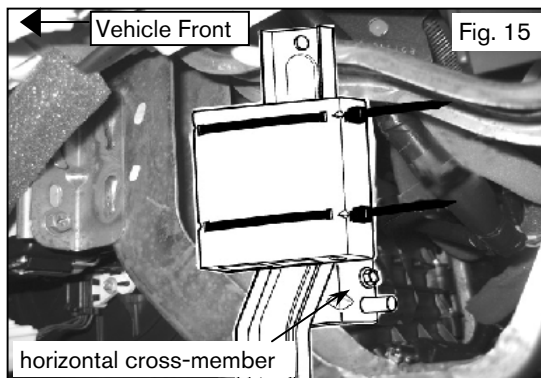
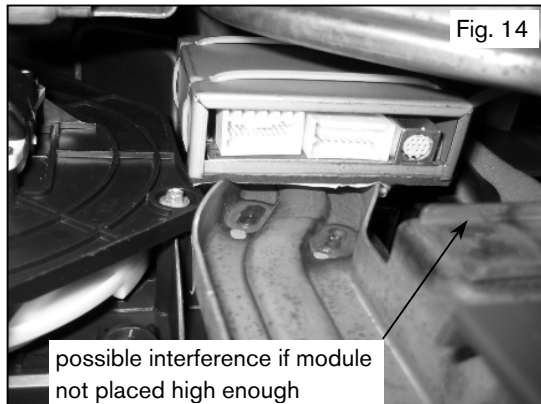

- (1) Using the provided alcohol wipe clean the bottom of the module and mounting location. Attach provided double-sided tape to bottom of chassis. Do not peel off the tape protector on the other side yet.
 - (2) Thread the two (2) large cable ties through the holes in the chassis from right to left when orientated as shown (connectors towards you). Ensure that the cable ties are pulled through with no slack and the head is pulled right up to chassis. Fig. 13
 - (3) Attach another two (2) large cable ties, one to each of the threaded cable ties from the previous step. Fig. 13
 - (4) Cut the threaded cable ties from step 2 even with the head of the cable ties from step 3. Fig. 13
 - (5) Temporarily remove any cable tie clips from the vertical c-channel mounting location to provide more clearance.
 - (6) Peel the other tape protector off of the double sided tape. Now the assembly can be put into place. It is to be located on vertical c-channel frame above the cross member that runs horizontally. Both cable ties should be above that cross-member. Fig. 14 & 15
- ⚠ CAUTION**

Ensure that the large cable ties do not wrap around any other cables or objects.
- NOTE**

The mini-DIN connector will have interference issues if the chassis is not placed high enough.
- (7) Wrap cable ties around vertical c-channel. Tighten the cable ties as much as possible to minimize movement. Plug the cables into the assembly. Fig. 14 & 15
 - (8) Take the ground wire tapped off of the N-bus harness and route towards bolt to the left of module mounting location. Fig. 16
 - (9) Use an 10mm socket to remove the bolt. Insert the eyelet connector. Tighten the bolt back down to secure the eyelet. Fig. 16

13. OPERATION CHECK:

- (1) Connect the battery negative terminal.
- (2) Turn vehicle ignition switch to the "ACC" position.
- (3) Reference the vehicle specific Satellite Radio Installation Instructions for further information. If Satellite radio was part of installation turn radio on then select satellite radio mode. Acquiring (Sirius) or Loading (XM) will display for a while. If not, move vehicle to outside and try again.
- (4) If Satellite radio was part of installation tune to preview channel (XM: channel "1" / Sirius: channel "184") to make sure receiving preview channel correctly. For Sirius tuner installations the preview channel may not be accessible. For further information reference the Operation Check section of the vehicle specific Satellite Radio Installation Instructions.
- (5) Confirm proper audio operation. (AM / FM / SAT / TAPE / CD)
- (6) Confirm accelerator pedal function per service manual.
- (7) If no iPod is present the head unit display should show "NO IPOD". If an iPod is connected to the system a check mark should be displayed on the iPod screen and audio should start playing in 5-20 seconds.
- (8) A full diagnostic tree is available on the next page for troubleshooting the system.

14. REINSTALLATION OF REMOVED PARTS:

- (1) Re-install all removed vehicle parts referring to the service manual for the vehicle.

 **CAUTION**

Use caution when re-installing interior components to avoid damage, scratches, or breaking of mounting clips. Refer to the vehicle specific service manual for more information.

- (2) Clean interior of vehicle.

15. FINAL INSPECTION:

- (1) Inspect the vehicle interior and exterior for damage.
- (2) Confirm proper operation of vehicle systems.
- (3) Reset radio presets to the recorded settings.
- (4) If equipped, verify proper sunroof operation and perform the reset procedure if necessary. Refer to Service Manual requirements.
- (5) Place the Owners Manual and Quick Reference Card in the customers glove box.

NISSAN IPOD INTERFACE DIAGNOSTIC FLOW CHART

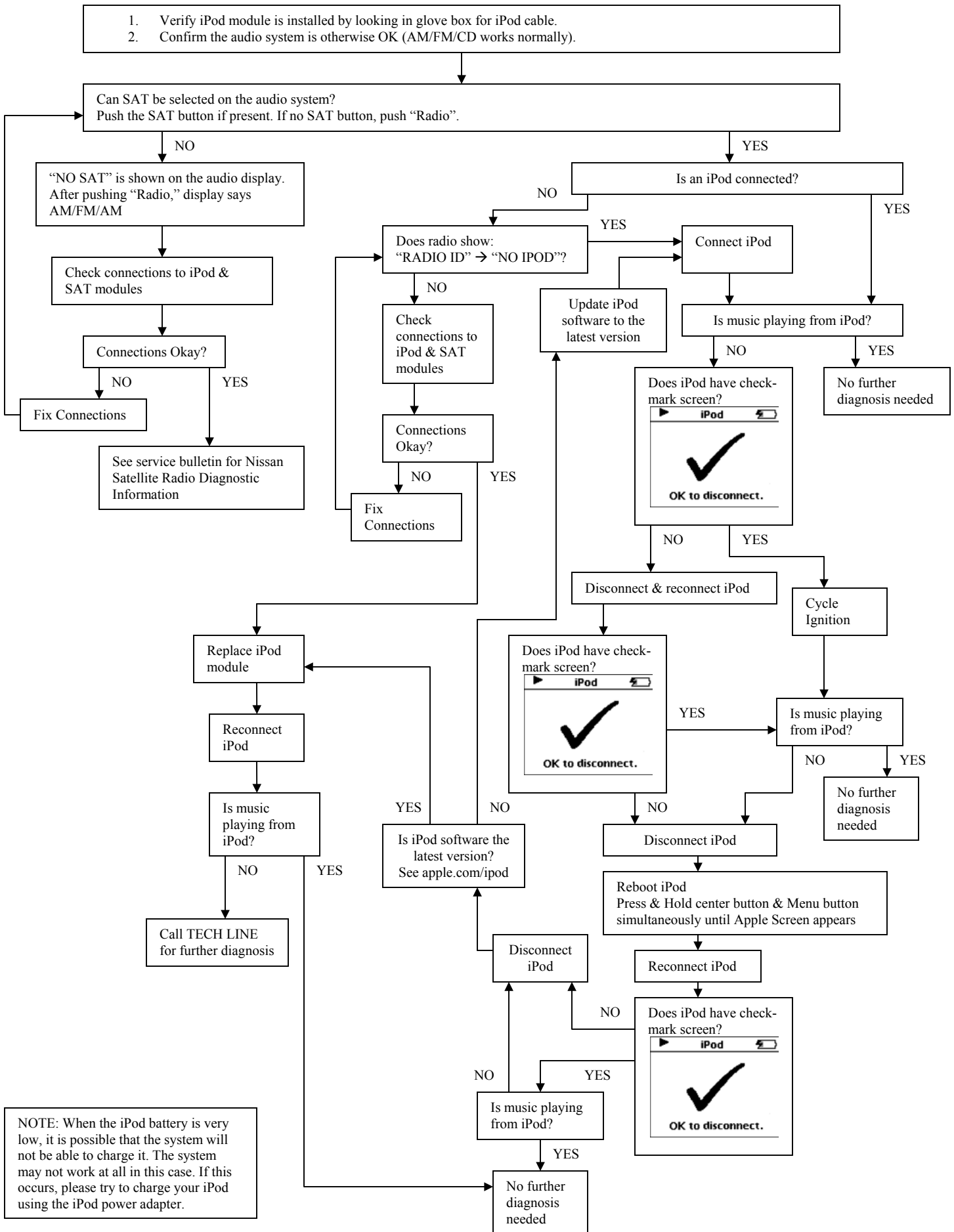

NOTE: When the iPod battery is very low, it is possible that the system will not be able to charge it. The system may not work at all in this case. If this occurs, please try to charge your iPod using the iPod power adapter.